

500ML MULTILAYER BAGS pack of 5

CODE: MB-1505

PCS/BOX: 150

WEIGHT: 34g

1. Renolit Solmed Medipak UVO 9002 400 micron
2. Black graduated scale
3. Coex Ø4.8x6.8mm tubes (PUR-EVA)
4. Coex Ø6X8mm tube (PUR-EVA)
5. Infusion port (ABS)
6. Safety cap for infusion port (LDPE)
7. Inviolable clamp (SBC)
8. Spike port (PVC DEHP free)
9. Female connector (ABS)
10. Male vented cap (ABS)
11. Male cap blister packaging (ABS)
12. Paper/PE envelope

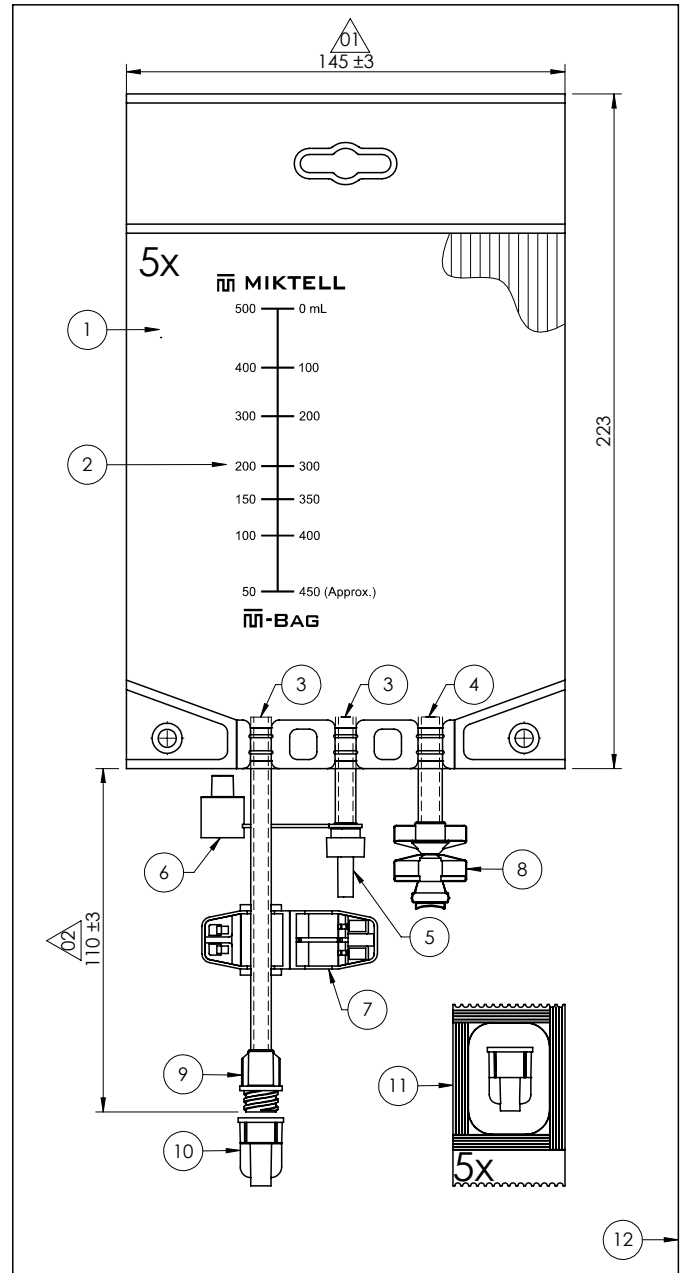

DEHP FREE

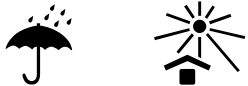

Intended use

Container for nutrition solutions prior and during administration to a patient.

Controls

Test to check sterilization and to detect pyrogenic substances, control to check flow and seal.

Chemical control of components in accordance with the European Pharmacopoeia (Current edition).

Sterilization

Product sterilized with ethylene oxide (E.O.). Validity: 5 years from sterilization date.

Packing

Single package product in a Paper/PE envelope.

The product is supplied sterile and non pyrogenic.

Storage

Normal storage procedures.

Disposal

Please follow the current laws on hospital waste disposal.

Miktell Ltd
 Aston Court
 Kingsmead Business Park
 Frederick Place
 High Wycombe
 Hp11 1JU
 United Kingdom
 T. +44 (0)1494 616 082
 F. +44 (0)1494 616 243



00	13/05/2021	Emission
REV	DATE	DESCRIPTION
00	13/05/2021	Emission